

NEWS
2020

 EDILKAMIN

MK Technika Grzewcza i Klimatyzacja

45-368 Opole, ul. Ozimska 53

tel. 77 453-14-14, 77 402-14-70, 77 402-14-71

fax 77 402-14-70, 77 402-14-71

e-mail: biuro@mk.net.pl

www.mk.net.pl



2020



Edilkamin S.p.A. sostiene il progetto "Italia che rinnova" che valorizza il riscaldamento da biomasse legnose come risorsa fondamentale per le famiglie, per l'ambiente e per l'economia. Scopri di più su italiacherinnova.com

NEWS
2020



Collezione 2020: benvenuti nel calore del futuro.

COLLECTION 2020 : BIENVENUS DANS LA CHALEUR DU FUTUR.

COLECCIÓN 2020: BIENVENIDOS AL CALOR DEL FUTURO.

KOLLEKTION 2020: WILLKOMMEN IN DER WÄRME DER ZUKUNFT.

2020 COLLECTION: WELCOME INTO THE HEATING OF THE FUTURE.

Dania Air tight
Dania Air Tight Plus
p. 8

Dania Air tight C
Dania Air Tight C Plus
p. 11

Celia Air Tight
Celia Air Tight Plus
p. 12

Celia Air tight C
Celia Air Tight C Plus
p. 15

STUFE A PELLETT STAGNE |
POÊLES À PELLETS ÉTANCHES | ESTUFAS DE PELLETT ESTANCAS |
RAUMLUFTUNABHÄNGIGE* PELLETTÖFEN | AIR TIGHT PELLETT STOVES



Yana
Yana Plus
p. 17

Lena
Lena Plus
p. 18-21

Micol
Micol Plus
p. 23

Myrna
Myrna Plus
Myrna Q
Myrna Q Plus
p. 24



FOCOLARI A LEGNA | CHEMINÉES À BOIS | CHIMENEAS DE LEÑA |
HOLZKAMINEINSÄTZE | WOOD FIREPLACES

Windo 70
Windo 90
Windo 100
Windo 120
p. 26-29

Blokk 70
Blokk 90
p. 26,31

Windo 70 T
Windo 90 T
p. 26,32

Blokk 70 T
Blokk 90 T
p. 26,33



STUFE A PELLETT | POÊLES À PELLETS |
ESTUFAS DE PELLETT | PELLETTÖFEN | PELLETT STOVES

TERMOSTUFE A PELLETT | THERMOPOÊLES À PELLETS | TERMO-ESTUFAS DE PELLETT |
WASSERGEFÜHRTE PELLETTÖFEN | PELLETT THERMO-STOVES



Milla H 15
p. 34

Myrna H 15
p. 37



Widro 55
Widro 65
Widro 85
p. 39

TERMOCAMINI A LEGNA | THERMOCHÉMINÉES À BOIS | TERMO-CHIMENEAS DE LEÑA |
WASSERGEFÜHRTE HOLZ-KAMINEINSÄTZE | WOOD THERMO-FIREPLACES



Gora 22
Gora 26
Gora 29
p. 40

Gora Slim
p.43

CALDAIE A PELLETT | CHAUDIÈRES À GRANULÉS | CALDEIRAS A PELLETS |
PELLETTHEIZKESSEL | PELLETT BOILERS

MIND REMOTE: il calore di domani, oggi nelle vostre mani.

MIND REMOTE: la chaleur de demain, dans vos main ce jour.

MIND REMOTE: el calor del mañana, hoy en sus manos.

MIND REMOTE: Die Wärme der Zukunft, schon heute in Ihren Händen.

MIND REMOTE: the heat of tomorrow, today in your hands.



APRITE LA MENTE AL CALORE DOMOTICO.

OUVREZ VOTRE ESPRIT À LA CHALEUR DOMOTIQUE.

ABRAN SU MENTE AL CALOR DOMÓTICO.

ÖFFNEN SIE IHREN GEIST FÜR DIE WÄRME DER HAUSAUTOMATION.

OPEN YOUR MIND TO THE DOMOTIC HEAT.

Il nuovo sistema che connette
la stufa a pellet con la rete wi-fi di casa.

- _ facile utilizzo con radiocomando, APP o assistente vocale
- _ riscaldamento perfetto e sempre sotto controllo
- _ centro assistenza vicino, anche da remoto

*Le nouveau système qui relie
le poêle à granulés thermique au réseau wi-fi domestique.*

- _ facile à utiliser avec radiocomande, APP ou assistant vocal
- _ chauffage parfait et toujours sous contrôle
- _ centre d'assistance proche, même géré à distance

El nuevo sistema que conecta
la estufa de pellets con la red wi-fi de casa.

- fácil uso con control remoto, APP o asistente vocal
- _ calefacción perfecta y siempre bajo control
- _ centros de servicios cercanos, incluso de forma remota

*Das neue System, das den
Pelletofen mit dem Heim-WLAN-Netzwerk verbindet.*

- _ einfache Verwendung mit Funkbedienung, APP oder Sprachassistent
- _ perfektes Wärmen und immer unter Kontrolle
- _ naher Kundendienst durch Fernwartung

The new system connecting
a pellet stove to your home wifi network.

- _ easy to use with a remote control, APP or voice attendant
- _ perfect always monitored heating
- _ nearby Assistance Centre, in remote mode as well



Dania Air Tight | Dania Air Tight Plus

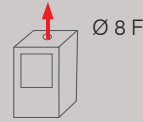

* 6 kW 155 m³

* 8 kW 210 m³ 57x54x96h cm

Finchi in acciaio grigio o in vetro bianco o nero

Flancs en acier gris ou verre blanc ou noir

Laterales acero gris o in cristal blanco o negro

Seitenteile aus grauem Stahl oder in weißem oder schwarzem Glas

Grey steel sides or white or black glass

Focolare in ghisa

Foyer en fonte

Hogar de fundición

Fuerraum aus Gusseisen

Cast iron combustion chamber

Aria calda canalizzabile posteriore Ø 6 cm (Dania Air Tight Plus)

Air chaud canalisable par l'arrière Ø 6 cm (Dania Air Tight Plus)

Aire caliente canalizable posterior Ø 6 cm (Dania Air Tight Plus)

Warmluftkanalisierung hinten Ø 6 cm (Dania Air Tight Plus)

Ductable hot air on rear Ø 6 cm (Dania Air Tight Plus)

Radiocomando "Mind Remote"

Radiocommande "Mind Remote"

Radiomando "Mind Remote"

Funkfernbedienung "Mind Remote"

"Mind Remote" remote control

Wi-Fi integrato

Wi-Fi intégré

Wi-Fi integrato

Integriertes WI-FI

Built in WIFI

Programmazione giornaliera/settimanale

Programmation journalière/hebdomadaire

Programación diaria/semanal

Tages-/Wochen-Zeitprogrammierung

Daily/weekly program

Optional:

- combinatore telefonico
- Kit per canalizzazione
- bocchette Split, Bent, Origami, Sharp

En option:

- *Combinateur téléphonique*
- *Kit pour canalisation*
- *bouches Split, Bent, Origami, Sharp*

Optional:

- Combinador telefónico
- Kit para canalización
- Bocas de canalización Split, Bent, Origami y Sharp

Optional:

- *Telefonschalter Ausrüstung*
- *Kit für die Warmluftverteilung*
- *Luftauslässen der Warmluftverteilung Split, Bent, Origami, Sharp*

Optional:

- Telephone switcher
- Kit for warm-air ducting
- Ducting vents Split, Bent, Origami, Sharp



CSTB

Sous Avis Technique
en cours de validation

Dania Air Tight Plus

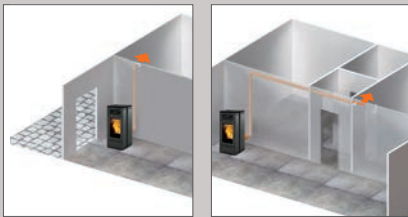

Acciaio | *Acier* | Acero
Stahl | Steel



Vetro | *Verre* | Cristal
Glas | Glass

* Prodotti in fase di certifica | *En cours de certification* | En fase de certificación | *In der Zertifizierungsphase* | Certification in progress



Vetro bianco
Verre blanc
Cristal blanco
Weißes Glas
White glass



Vetro nero
Verre noir
Cristal negro
Schwarzes Glas
Black glass



Acciaio grigio
Acier gris
Acero gris
Grauer Stahl
Grey steel

Dania Air Tight C

* 6 kW 155 m³



Dania Air Tight C Plus

* 8 kW 210 m³ 57x55,5x96h cm

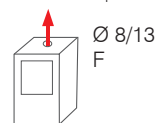

Fianchi in acciaio grigio o in vetro bianco o nero

Flancs en acier gris ou verre blanc ou noir

Laterales acero gris o in cristal blanco o negro

Seitenteile aus grauem Stahl oder in weißem oder schwarzem Glas

Grey steel sides or white or black glass

Focolare in ghisa

Foyer en fonte

Hogar de fundición

Feuerraum aus Gusseisen

Cast iron combustion chamber

Aria calda canalizzabile posteriore Ø 6 cm (Dania Air Tight C Plus)

Air chaud canalisable par l'arrière Ø 6 cm (Dania Air Tight C Plus)

Aire caliente canalizable posterior Ø 6 cm (Dania Air Tight C Plus)

Warmluftkanalisierung hinten Ø 6 cm (Dania Air Tight C Plus)

Ductable hot air on rear Ø 6 cm (Dania Air Tight C Plus)

Radiocomando "Mind Remote"

Radiocommande "Mind Remote"

Radiomando "Mind Remote"

Funkfernbedienung "Mind Remote"

"Mind Remote" remote control

Wi-Fi integrato

Wi-Fi intégré

Wi-Fi integrado

Integriertes Wi-Fi

Built in WiFi

Programmazione giornaliera/settimanale

Programmation journalière/hebdomadaire

Programación diaria/semanal

Tages-/Wochen-Zeitprogrammierung

Daily/weekly program

Optional:

- combinatore telefonico
- Kit per canalizzazione
- bocchette Split, Bent, Origami, Sharp

Optional:

- Combinateur téléphonique
- Kit pour canalisation
- bouches Split, Bent, Origami, Sharp

Opcional:

- Combinador telefónico
- Kit para canalización
- Bocas de canalización Split, Bent, Origami y Sharp

Optional:

- Telefonschalter Ausrüstung
- Kit für die Warmluftverteilung
- Luftauslässen der Warmluftverteilung Split, Bent, Origami, Sharp

Optional:

- Telephone switcher
- Kit for warm-air ducting
- Ducting vents Split, Bent, Origami, Sharp



CSTB

Sous Avis Technique
en cours de validation

Dania Air Tight C Plus

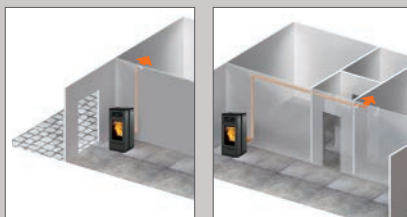

Acciaio | Acier | Acero
Stahl | Steel



Vetro | Verre | Cristal
Glas | Glass

* nach EN-Normentwurf

* Prodotti in fase di certifica | En cours de certification | En fase de certificación | In der Zertifizierungsphase | Certification in progress



INSTALLAZIONE CON TUBO COASSIALE
INSTALLATION AVEC TUYAU COAXIAL
INSTALACIÓN CON TUBO COAXIAL
INSTALLATION MIT KOAXIALES ABGASROHR
COAXIAL PIPE INSTALLATION

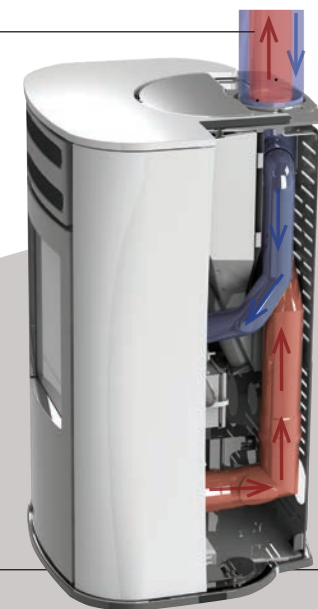

Celia Air Tight | Celia Air Tight Plus

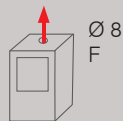

*7 kW 180 m³

*9 kW 235 m³ 54x57x111h cm

Fianchi in acciaio nero o in vetro bianco o nero

Flancs en acier noir ou verre blanc ou noir

Laterales acero negro o in cristal blanco o negro

Seitenteile aus schwarzem Stahl oder in weißem oder schwarzem Glas

Black steel sides or white or black glass

Porta esterna totalmente in vetro

Porte externe entièrement en verre

Puerta externa totalmente de cristal

Außentür vollständig aus Glas

Fully glazed external door

Doppia porta di chiusura

Double porte de fermeture foyer

Doble puerta de cierre

Doppelte Verschlusstür für Feuerraum

Double door on the combustion chamber

Focolare in ghisa

Foyer en fonte

Hogar de fundición

Feuerraum aus Gusseisen

Cast iron combustion chamber

Aria calda canalizzabile posteriore Ø 6 cm (Celia Air Tight Plus)

Air chaud canalisable par l'arrière Ø 6 cm (Celia Air Tight Plus)

Aire caliente canalizable posterior Ø 6 cm (Celia Air Tight Plus)

Warmluftkanalisierung hinten Ø 6 cm (Celia Air Tight Plus)

Ductable hot air on rear Ø 6 cm (Celia Air Tight Plus)

Radiocomando "Mind Remote"

Radiocommande "Mind Remote"

Radiomando "Mind Remote"

Funkfernbedienung "Mind Remote"

"Mind Remote" remote control

Wi-Fi integrato

Wi-Fi intégré

Wi-Fi integrato

Integriertes Wi-Fi

Built in WIFI

Programmazione giornaliera/settimanale

Programmation journalière/hebdomadaire

Programación diaria/semanal

Tages-/Wochen-Zeitprogrammierung

Daily/weekly program

Optional:

- Combinatore telefonico
- Kit per canalizzazione
- Bocchette Split, Bent, Origami, Sharp

En option:

- Combinateur téléphonique
- Kit pour canalisation
- Bouches Split, Bent, Origami, Sharp

Opcional:

- Combinador telefónico
- Kit para canalización
- Bocas de canalización Split, Bent, Origami y Sharp

Optional:

- Telefonschalter Ausrüstung
- Kit für die Warmluftverteilung
- Luftauslässen der Warmluftverteilung Split, Bent, Origami, Sharp

Optional:

- Telephone switcher
- Kit for warm-air ducting
- Ducting vents Split, Bent, Origami, Sharp



CSTB

Sous Avis Technique
en cours de validation

Celia Air Tight Plus

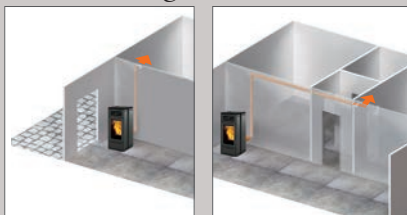

Acciaio | Acier | Acero
Stahl | Steel



Vetro | Verre | Cristal
Glas | Glass

Top scorrevole per il caricamento del pellet
Top coulissant pour le chargement du pellets
Tapa corrediza para la carga del pellet
Verschiebbares Oberteil für die Pelleteinfüllung
Sliding top for feeding pellet





Acciaio nero
Acier noir
Acero negro
Schwarzer Stahl
Black steel

Vetro bianco
Verre blanc
Cristal blanco
Weißes Glas
White glass



Celia Air Tight C



Celia Air Tight C Plus



*7 kW 180 m³

*9 kW 235 m³ 54x58,5x111h cm

Fianchi in acciaio nero o in vetro bianco o nero

Flancs en acier noir ou verre blanc ou noir

Laterales acero negro o in cristal blanco o negro

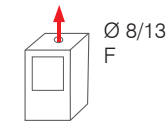

Seitenteile aus schwarzem Stahl oder in weißem oder schwarzem Glas

Black steel sides or white or black glass

Porta esterna totalmente in vetro

Porte externe entièrement en verre

Puerta externa totalmente de cristal

Außentür vollständig aus Glas

Fully glazed external door

Doppia porta di chiusura

Double porte de fermeture foyer

Doble puerta de cierre

Doppelte Verschlusstür für Feuerraum

Double door on the combustion chamber

Focolare in ghisa

Foyer en fonte

Hogar de fundición

Feuerraum aus Gusseisen

Cast iron combustion chamber

Top scorrevole per il caricamento del pellet

Top coulissant pour le chargement du pellets

Tapa corrediza para la carga del pellet

Verschiebbares Oberteil für die Pelletseinfüllung

Sliding top for feeding pellet

Aria calda canalizzabile posteriore Ø 6 cm (Celia Air Tight C Plus)

Air chaud canalisable par l'arrière Ø 6 cm (Celia Air Tight C Plus)

Aire caliente canalizable posterior Ø 6 cm (Celia Air Tight C Plus)

Warmluftkanalisierung hinten Ø 6 cm (Celia Air Tight C Plus)

Ductable hot air on rear Ø 6 cm (Celia Air Tight C Plus)

Radiocomando "Mind Remote"

Radiocommande "Mind Remote"

Radiomando "Mind Remote"

Funkfernbedienung "Mind Remote"

"Mind Remote" remote control

Wi-Fi integrato

Wi-Fi intégré

Wi-Fi integrado

Integriertes Wi-Fi

Built in WIFI

Programmazione giornaliera/settimanale

Programmation journalière/hebdomadaire

Programación diaria/semanal

Tages-/Wochen-Zeitprogrammierung

Daily/weekly program

Optional:

- combinatore telefonico
- Kit per canalizzazione
- bocchette Split, Bent, Origami, Sharp

Optional:

- Combinateur téléphonique
- Kit pour canalisation
- bouches Split, Bent, Origami, Sharp

Opcional:

- Combinador telefónico
- Kit para canalización
- Bocas de canalización Split, Bent, Origami y Sharp

Optional:

- Telefonschalter Ausrüstung
- Kit für die Warmluftverteilung
- Luftauslässen der Warmluftverteilung Split, Bent, Origami, Sharp

Optional:

- Telephone switcher
- Kit for warm-air ducting
- Ducting vents Split, Bent, Origami, Sharp



CSTB

Sous Avis Technique
en cours de validation

Celia Air Tight C Plus

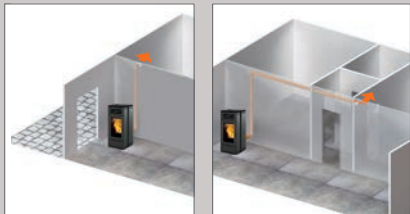

Acciaio | Acier | Acero
Stahl | Steel



Vetro | Verre | Cristal
Glas | Glass

INSTALLAZIONE CON TUBO COASSIALE
INSTALLATION AVEC TUYAU COAXIAL
INSTALACIÓN CON TUBO COAXIAL
INSTALLATION MIT KOAXIALES ABGASROHR
COAXIAL PIPE INSTALLATION



*nach EN-Normenentwurf

* Prodotti in fase di certifica | En cours de certification | En fase de certificación | In der Zertifizierungsphase | Certification in progress





Ceramica bianco opaco
Céramique blanc opaque
Cerámica blanco mate
Mattweiße Keramik
Ceramic matt white

Yana | Yana Plus



6,9 kW 180 m³ | 9,2 kW 240 m³ 52x53x102h cm

Finchi in acciaio con top e inserti in ceramica bianco opaco, nero opaco o in pietra ollare

Flancs en acier top et insert en céramique blanc opaque, noire opaque ou en pierre ollaire

Laterales acero con top y decoraciones de cerámica blanco mate, negro mate o piedra natural

Seitenteile aus Stahl, Top aus matter weißer oder schwarzer Keramik, oder Naturstein

Steel sides, top in ceramic matt white or black or Soapstone

Focolare in ghisa

Foyer en fonte

Hogar de fundición

Feuerraum aus Gusseisen

Cast iron combustion chamber

Aria calda canalizzabile posteriore Ø 6 cm (Yana Plus)

Air chaud canalisable par l'arrière Ø 6 cm (Yana Plus)

Aire caliente canalizable posterior Ø 6 cm (Yana Plus)

Warmluftkanalisierung hinten Ø 6 cm (Yana Plus)

Ductable hot air on rear Ø 6 cm (Yana Plus)

Radiocomando "Mind Remote"

Radiocommande "Mind Remote"

Radiomando "Mind Remote"

Funkfernbedienung "Mind Remote"

"Mind Remote" remote control

Wi-Fi integrato

Wi-Fi intégré

Wi-Fi integrado

Integriertes Wi-Fi

Built in WIFI

Programmazione giornaliera/settimanale

Programmation journalière/hebdomadaire

Programación diaria/semanal

Tages-/Wochen-Zeitprogrammierung

Daily/weekly program

Optional:

- Combinatore telefonico
- Kit per canalizzazione
- bocchette Split, Bent, Origami, Sharp
- Spia riserva pellet

En option:

- *Combinateur téléphonique*
- *Kit pour canalisation*
- *Bouches Split, Bent, Origami, Sharp*
- *Sonde réservoir granulés*

Opcional:

- Combinador telefónico
- Kit para canalización
- Bocas de canalización Split, Bent, Origami y Sharp
- Sonda de reserva pellet

Optional:

- *Telefonschalter Ausrüstung*
- *Kit für die Warmluftverteilung*
- *Luftauslässen der Warmluftverteilung Split, Bent, Origami, Sharp*
- *Pellet-Füllstandsensor*

Optional:

- Telephone switcher
- Kit for warm-air ducting
- Ducting vents Split, Bent, Origami, Sharp
- Pellet level sensor





Classe ambientale DM 186 ★★★★★ Yana

Classe ambientale DM 186 ★★★★★ Yana Plus

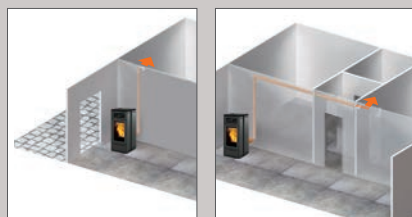
Yana Plus



Top scorrevole per il caricamento del pellet
 Top coulissant pour le chargement du pellets
 Tapa corrediza para la carga del pellet
 Verschiebbares Oberteil für die Pelletseinfüllung
 Sliding top for feeding pellet

  Ceramica | Céramique
 Cerámica | Keramik | Ceramic

 Pietra ollare | Pierre ollaire
 Piedra natural | Naturstein | Soapstone

Pietra ollare
 Pierre ollaire
 Piedra natural
 Naturstein
 Soapstone













Lena | Lena Plus

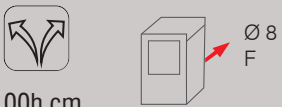





7,9 kW 205 m³ | 9,2 kW 240 m³ 50x49x100h cm

<p>Fianchi in pietra ollare o in acciaio, o con inserti in ceramica bianco opaco o pietra ollare</p> <p>Focolare in ghisa</p> <p>Aria calda canalizzabile posteriore Ø 6 cm (Lena Plus)</p> <p>Radiocomando "Mind Remote"</p> <p>Wi-Fi integrato</p> <p>Programmazione giornaliera/settimanale</p> <p>Optional:</p> <ul style="list-style-type: none"> • Combinatore telefonico • Kit per canalizzazione • Bocchette Split, Bent, Origami, Sharp • Spia riserva pellet 	<p><i>Flancs en pierre ollaire ou acier, ou avec inserts en céramique blanc opaque ou en pierre ollaire</i></p> <p><i>Foyer en fonte</i></p> <p><i>Air chaud canalisable par l'arrière Ø 6 cm (Lena Plus)</i></p> <p><i>Radiocommande "Mind Remote"</i></p> <p><i>Wi-Fi intégré</i></p> <p><i>Programmation journalière/hebdomadaire</i></p> <p><i>En option:</i></p> <ul style="list-style-type: none"> • <i>Combinateur téléphonique</i> • <i>Kit pour canalisation</i> • <i>bouches Split, Bent, Origami, Sharp</i> • <i>Sonde réservoir granulés</i> 	<p>Laterales de piedra natural o acero, o acero con decoraciones de cerámica blanco mate o piedra natural</p> <p>Hogar de fundición</p> <p>Aire caliente canalizable posterior Ø 6 cm (Lena Plus)</p> <p>Radiomando "Mind Remote"</p> <p>Wi-Fi integrado</p> <p>Programación diaria/semanal</p> <p>Opcional:</p> <ul style="list-style-type: none"> • Combinador telefónico • Kit para canalización • Bocas de canalización Split, Bent, Origami y Sharp • Sonda de reserva pellet 	<p><i>Seitenteile aus Naturstein oder Stahl, oder aus weißer matter Keramik stahl Schwarzer oder Naturstein</i></p> <p><i>Feuerraum aus Gusseisen</i></p> <p><i>Warmluftkanalisierung hinten Ø 6 cm (Lena Plus)</i></p> <p><i>Funkfernbedienung "Mind Remote"</i></p> <p><i>Integriertes Wi-Fi</i></p> <p><i>Tages-/Wochen-Zeitprogrammierung</i></p> <p><i>Optional:</i></p> <ul style="list-style-type: none"> • <i>Telefonschalter Ausrüstung</i> • <i>Kit für die Warmluftverteilung</i> • <i>Luftauslässen der Warmluftverteilung Split, Bent, Origami, Sharp</i> • <i>Pellet-Füllstandsensor</i> 	<p>Soapstone or steel sides, or with matt white ceramic or soapstone inserts</p> <p>Cast iron combustion chamber</p> <p>Ductable hot air on rear Ø 6 cm (Lena Plus)</p> <p>"Mind Remote" remote control</p> <p>Built in WIFI</p> <p>Daily/weekly program</p> <p>Optional:</p> <ul style="list-style-type: none"> • Telephone switcher • Kit for warm-air ducting • Ducting vents Split, Bent, Origami, Sharp • Pellet level sensor
------------------------------------------------------------------------------------------------------------------------------------------------------------------------------------------------------------------------------------------------------------------------------------------------------------------------------------------------------------------------------------------------------------------------------------------------------------------------------------------------------------------	----------------------------------------------------------------------------------------------------------------------------------------------------------------------------------------------------------------------------------------------------------------------------------------------------------------------------------------------------------------------------------------------------------------------------------------------------------------------------------------------------------------------------------------------------------------------------------------------------	------------------------------------------------------------------------------------------------------------------------------------------------------------------------------------------------------------------------------------------------------------------------------------------------------------------------------------------------------------------------------------------------------------------------------------------------------------------------------------------------------------------------------	--------------------------------------------------------------------------------------------------------------------------------------------------------------------------------------------------------------------------------------------------------------------------------------------------------------------------------------------------------------------------------------------------------------------------------------------------------------------------------------------------------------------------------------------------------------------------------------------------------------------------------------------------	------------------------------------------------------------------------------------------------------------------------------------------------------------------------------------------------------------------------------------------------------------------------------------------------------------------------------------------------------------------------------------------------------------------------------------------------------------------------------

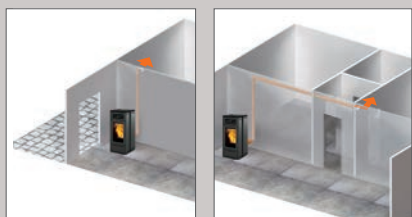

Lena Plus



 Acciaio <i>Acier</i> Acero <i>Stahl</i> Steel	 Pietra ollare <i>Pierre ollaire</i> Piedra natural <i>Naturstein</i> Soapstone	 Ceramica <i>Céramique</i> Cerámica <i>Keramik</i> Ceramic
-------------------------------------------------------------------------------------------------------------------------------------------	-----------------------------------------------------------------------------------------------------------------------------------------------------------------------------	--------------------------------------------------------------------------------------------------------------------------------------------------------

Pietra ollare
Pierre ollaire
Piedra natural
Naturstein
Soapstone





Pietra ollare
Pierre ollaire
Piedra natural
Naturstein
Soapstone

Ceramica bianco opaco
Céramique blanc opaque
Ceramica blanco mate
Mattweiße Keramik
Ceramic matt white



STUFE A PELLETT | POÊLES À PELLETS | ESTUFAS DE PELLETT | PELLETTÖFEN | PELLETT STOVES

Lena | Lena Plus



Acciaio nero
Acier noir
Acero negro
Schwarzer Stahl
Black steel



Micol | Micol Plus

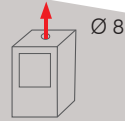

* 10 kW 260 m³ * 12 kW 315 m³ 55x56x114h cm

Acciaio grigio con fianchi in acciaio bianco opaco

Acier gris avec flancs en acier blanc opaque

Acero gris con laterales acero blanco mate

Grau Stahl mit Seitenteile aus mattweißem Stahl

Grey steel with sides in opaque white steel

Focolare in ghisa

Foyer en fonte

Hogar de fundición

Feuerraum aus Gusseisen

Cast iron combustion chamber

Aria calda canalizzabile posteriore Ø 8 cm (Micol Plus)

Air chaud canalisable par l'arrière Ø 8 cm (Micol Plus)

Aire caliente canalizable posterior Ø 8 cm (Micol Plus)

Warmluftkanalisierung hinten Ø 8 cm (Micol Plus)

Ductable hot air on rear Ø 8 cm (Micol Plus)

Radiocomando "Mind Remote"

Radiocommande "Mind Remote"

Radiomando "Mind Remote"

Funkfernbedienung "Mind Remote"

"Mind Remote" remote control

Wi-Fi integrato

Wi-Fi intégré

Wi-Fi integrado

Integriertes Wi-Fi

Built in WIFI

Programmazione giornaliera/settimanale

Programmation journalière/hebdomadaire

Programación diaria/semanal

Tages-/Wochen-Zeitprogrammierung

Daily/weekly program

Optional:

- Combinatore telefonico
- Kit per canalizzazione
- Bocchette Split, Bent, Origami, Sharp
- Spia riserva pellet

En option:

- Combinateur téléphonique
- Kit pour canalisation
- bouches Split, Bent, Origami, Sharp
- Sonde réservoir granulés

Opcional:

- Combinador telefónico
- Kit para canalización
- Bocas de canalización Split, Bent, Origami y Sharp
- Sonda de reserva pellet

Optional:

- Telefonschalter Ausrüstung
- Kit für die Warmluftverteilung
- Luftauslässen der Warmluftverteilung
- Split, Bent, Origami, Sharp
- Pellet-Füllstandsensor

Optional:

- Telephone switcher
- Kit for warm-air ducting
- Ducting vents Split, Bent, Origami, Sharp
- Pellet level sensor



Micol Plus

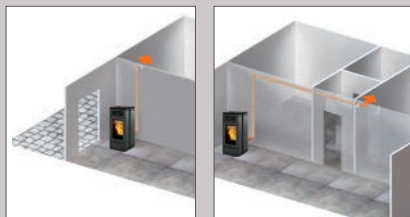

Acciaio | Acier
Acero | Stahl | Steel

* Prodotti in fase di certifica | En cours de certification | En fase de certificación | In der Zertifizierungsphase | Certification in progress



Myrna | Myrna Q | Myrna Plus | Myrna Q Plus

* 10 kW 260 m³ 54,5x55x112h cm

* 12 kW 315 m³ 54,5x55x112h cm

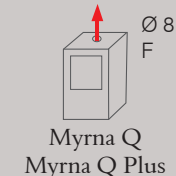
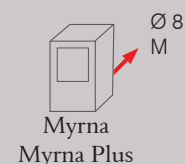

Acciaio con inserto frontale e top in ceramica bianco opaco, cipria o grigio chiaro opaco.

Acier avec insert frontal et top en céramique blanc opaque, rose poudré ou gris clair

Acero con detalle frontal y top en cerámica blanca opaca, cipria o gris claro

Stahl mit Fronteinsatz und Top aus matter weißer, puder oder hellgrauer Keramik

Steel with front insert and matt white, powder or light grey colors ceramic top

Focolare in ghisa

Foyer en fonte

Hogar de fundición

Feuerraum aus Gusseisen

Cast iron combustion chamber

Aria calda canalizzabile posteriore Ø 8 cm (Myrna Plus, Myrna Q Plus)

Air chaud canalisable par l'arrière Ø 8 cm (Myrna Plus, Myrna Q Plus)

Aire caliente canalizable posterior Ø 8 cm (Myrna Plus, Myrna Q Plus)

Warmluftkanalisierung hinten Ø 8 cm (Myrna Plus, Myrna Q Plus)

Ductable hot air on rear Ø 8 cm (Myrna Plus, Myrna Q Plus)

Radiocomando "Mind Remote"

Radiocommande "Mind Remote"

Radiomando "Mind Remote"

Funkfernbedienung "Mind Remote"

"Mind Remote" remote control

Wi-Fi integrato

Wi-Fi intégré

Wi-Fi integrado

Integriertes Wi-Fi

Built in WIFI

Programmazione giornaliera/settimanale

Programmation journalière/hebdomadaire

Programación diaria/semanal

Tages-/Wochen-Zeitprogrammierung

Daily/weekly program

Optional:

- Combinatore telefonico
- Kit per canalizzazione
- Bocchette Split, Bent, Origami, Sharp
- Spia riserva pellet

En option:

- Combinateur téléphonique
- Kit pour canalisation
- bouches Split, Bent, Origami, Sharp
- Sonde réservoir granulés

Opcional:

- Combinador telefónico
- Kit para canalización
- Bocas de canalización Split, Bent, Origami y Sharp
- Sonda de reserva pellet

Optional:

- Telefonschalter Ausrüstung
- Kit für die Warmluftverteilung
- Luftauslässen der Warmluftverteilung Split, Bent, Origami, Sharp
- Pellet-Füllstandsensor

Optional:

- Telephone switcher
- Kit for warm-air ducting
- Ducting vents Split, Bent, Origami, Sharp
- Pellet level sensor



Myrna Plus, Myrna Q Plus

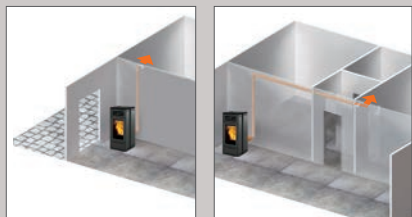

Ceramica | Céramique | Cerámica
Keramik | Ceramic

* Prodotti in fase di certifica | En cours de certification | En fase de certificación | In der Zertifizierungsphase | Certification in progress



Myrna
Myrna Plus
Ceramica bianco opaco
Céramique blanc opaque
Cerámica blanca opaca
Matt-Weiße Keramik
Matt white ceramic



Myrna Q
Myrna Q Plus
Ceramica cipria
Céramique rose poudré
Cerámica cipria
Puder Keramik
Powder ceramic

FOCOLARI EDILKAMIN: NASCE UNA NUOVA ESPERIENZA DI CAMINETTO.

CHEMINÉES EDILKAMIN: UNE NOUVELLE EXPÉRIENCE DE CHEMINÉE EST NÉE.

HOGARES EDILKAMIN: NACE UNA NUEVA EXPERIENCIA EN CHIMENEAS.

EDILKAMIN HOLZKAMINEINSAETZE: EIN NEUES KAMINFEUER-ERLEBNIS IST GEBOREN.

EDILKAMIN FIREPLACES: A NEW FIREPLACE "EXPERIENCE" IS BORN.

SCORREVOLEZZA E SILENZIOSITÀ DEL PORTELLONE SALISCENDI

La particolare tipologia di guide di alta qualità consente lo scorrimento fluido del portellone. In chiusura, il portellone rientra leggermente con un movimento morbido e automatico, senza sforzo. Il profilato esclusivo Edilkamin, è molto resistente per dare stabilità. L'apertura e chiusura del focolare sono silenziose e morbide, affidabili nel tempo.

AFFIDABILITÀ E DURATA NEL TEMPO

Le nuove guide consentono lo scorrimento del portellone senza sfregamento, preservando le guarnizioni.

DESIGN ESSENZIALE ED ELEGANTE

L'ampio vetro senza profili offre una spettacolare visione della fiamma. Un tocco di eleganza: le guide di colore nero sono molto discrete, quasi invisibili.

GLISSEMENT ET SILENCE DE LA PORTE

Le type particulier de guide de haute qualité permet le glissement en douceur de la porte. Lors de la fermeture de la porte, elle se rétracte légèrement avec un mouvement fluide et automatique, sans aucun effort. Le profil exclusif Edilkamin est très résistant pour donner de la stabilité. L'ouverture et la fermeture du foyer sont effectuées avec douceur et dans le plus grand silence, avec un système fiable dans le temps.

FIABILITÉ ET DURABILITÉ DANS LE TEMPS

Les guides de haute qualité permettent à la porte de glisser sans frottement, tout en préservant les garnitures.

DESIGN ESSENTIEL ET ÉLÉGANT

Le grand verre sans profils offre une vue spectaculaire sur la flamme. Une touche d'élégance: les guides noirs sont très discrets, presque invisibles.

GELÄUFIGKEIT UND STILLE DER HOCHSCHIEBBARE TÜR

Die besondere Bauart der hochwertigen Führungen ermöglicht ein reibungsloses Gleiten der Schiebetür. Beim Zuschließen fährt die Tür mit einer perfekten und automatischen Bewegung leicht ein. Das exklusive Edilkamin-Profil ist extrem widerstandsfähig, um Stabilität und gleichmäßige Bewegung zu gewährleisten. Das Öffnen und Schließen des Kamineinsatzes ist leise und sanft und im Laufe der Zeit zuverlässig.

ZUVERLÄSSIGKEIT UND HALTBARKEIT IM VERLAUF DER ZEIT

Die neue Führung garantiert ein reibungsloses Gleiten der Tür, wodurch die Dichtungen erhalten bleiben.

ESSENZIELLES UND ELEGANTES DESIGN

Das große Glas ohne Profile bietet einen spektakulären Blick auf die Flamme. Ein Hauch von Eleganz: Die schwarzen Schienen sind sehr diskret, fast unsichtbar.

PUERTA GUILLOTINA DE FÁCIL DESLIZAMIENTO Y SILENCIOSA.

La particular tipología de las guías de alta calidad, permiten el deslizamiento fluido de la puerta.

Al cerrarse, la puerta vuelve a entrar ligeramente con un movimiento fluido y automático, sin esfuerzo.

El perfil exclusivo Edilkamin es muy resistente para dar estabilidad.

La apertura y el cierre del hogar son silenciosos y suaves, fiables en el tiempo.

FIABLE Y DE LARGA DURACIÓN.

Las guías de alta calidad permiten el deslizamiento de la puerta evitando roces, preservando las juntas.

DISEÑO ESENCIAL Y ELEGANTE

El amplio cristal sin perfiles ofrece una espectacular visión de la llama. Un toque de elegancia: las guías de color negro son muy discretas, casi invisibles.

SMOOTH AND SILENT DOOR UPS AND DOWNS

This special type of high-quality guide rails, allow a smoother door sliding.

The door is indeed slightly receding with a soft and automatic move while closing, without any effort.

Edilkamin unique streamlined profile is highly resistant, able to provide strength.

Door opening and closing are soft, silent and reliable over time.

RELIABILITY AND LONG LIFETIME

High quality guide rails allowing the door to slide with no friction, preserving gaskets.

ESSENTIAL AND STYLISH DESIGN

A large glass without profiles, just offering a unique flame view. A touch of style: black coloured discreet guide rails, nearly invisible.

REFRATTARIO BIANCO O NERO: STESSA FORZA, DIVERSA LUCE.

L'interno può essere in refrattario bianco o nero con una diversa resa estetica della fiamma. In particolare, il refrattario nero risulta brillante e non poroso, grazie alla doppia smaltatura.

RÉFRACTAIRE BLANC OU NOIR: MÊME FORCE, JUSTE UNE DIFFÉRENCE DE LUMIÈRE.

L'intérieur peut être en réfractaire blanc ou noir avec pour différence, le rendu esthétique de la flamme. Précision, le réfractaire noir est brillant, grâce au double vitrage.

REFRACTARIO BLANCO O NEGRO: MISMA FUERZA, DIFERENTE LUMINOSIDAD.

El interior puede ser en refractario blanco o negro con un diferente rendimiento estético de la llama. En particular, el refractario negro resulta brillante, gracias a l doble esmaltado.



**WEISSE ODER SCHWARZE
SCHAMOTTSTEINE: DIESELBE
FESTIGKEIT, UNTERSCHIEDLI-
CHE AUSSTRAHLUNG**

Der Innenraum kann mit weißen oder schwarzen Schamottesteinen verkleidet werden um unter unterschiedlichen anmutsvollen Flammenbilder wählen zu können. Insbesondere der schwarze Schamottestein wirkt glänzend, dank der doppelten Emailierung.

BLACK OR WHITE REFRACTORY: SAME STRENGTH, DIFFERENT LIGHT.

Lining is available in black or white refractory with a different flame shape rendering. The black refractory above all, appearing bright thanks to a double glazing.

FACILITÀ D'USO La maniglia è fissa per essere sempre dove serve, quando serve! Per agevolare la pulizia del vetro, il portellone si apre anche a ribalta. Piedini con ruote per agevolare lo spostamento durante l'installazione.

FACILITE D'UTILISATION La poignée est fixe pour être toujours là où vous en avez besoin, quand vous en avez besoin! Pour faciliter le nettoyage de la vitre, la porte s'ouvre également vers l'avant. Pieds avec roues pour faciliter le mouvement lors de l'installation.

FACILIDAD DE USO La maneta es fija, para estar siempre donde debe estar cuando hace falta! Para favorecer la limpieza del cristal, la puerta se abre también hacia adelante (abatible). Pies con ruedas para facilitar el movimiento durante la instalación

FIAMMA PERSONALIZZABILE

Il portellone molto stabile e la chiusura rientrante offrono una regolazione efficace della combustione, regalando l'esperienza di una fiamma come piace a voi: più luminosa e di carattere oppure lieve e d'atmosfera.

Le guarnizioni ottimizzano la tenuta del focolare.

FLAMME PERSONNALISABLE

Avec la fermeture de la porte rétractable, cela vous apporte une régulation très pointue et efficace de la combustion, en vous offrant l'expérience d'une flamme comme vous l'aimez: plus lumineuse avec du caractère ou légère pour une d'ambiance feutrée.

De plus les garnitures optimisent l'étanchéité du foyer.

LLAMA PERSONALIZABLE

La puerta muy estable y el cierre de retorno ofrecen un control eficaz de la combustión, dando la experiencia de una llama como a usted le gusta: más brillante y de carácter creando una atmosfera ligera. Las juntas optimizan la resistencia del hogar.

EINFACHE NUTZUNG Der Griff ist fest, damit es immer dort ist, wo Sie es brauchen, wenn Sie es brauchen! Einfache Reinigung der Scheibe (Klappenöffnung). Füße mit Rädern zur Erleichterung der Bewegung während der Installation.

EASY TO USE Handle is fixed and fitted right where it is needed, when necessary! Door tilt opening, will also ease the glass cleaning. Pivoting wheels easing handling while fitting

Leva di regolazione combustione
Réglage de l'air de combustion au moyen de la commande
Palanca de regulación de combustión
Verbrennung Einstellhebel
Combustion setting lever

REGELBARES FLAMMENBILD

Die sehr stabile Türbauart und der zurücktretende Verschluss bieten eine effektive Verbrennungsregelung und bieten Ihnen das Erlebnis einer Flamme, wie Sie es am liebsten mögen: heller und mit Charakter oder weich und stimmungsvoll.

Die Dichtungen optimieren die Abdichtung des Feuerraumes.

"TAILORMADE" FLAME

The very stable door with its receding lock, provides a suitable combustion setting, offering you the experience of a pleasant flame view: brighter and tempered or just of good mood and mild. Not to mention gaskets, also enhancing the hearth tightness.



Windo 70 | Windo 90 | Windo 100 | Windo 120

14,3 kW 375 m³ 93x53x135h cm * 17 kW 445 m³ 113x53x153h cm * 18 kW 470 m³ 123x53x135h cm * 19 kW 495 m³ 143x53x135h cm

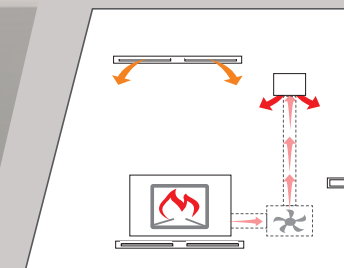
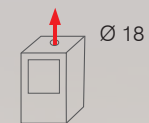

KIT AIR DIFFUSER

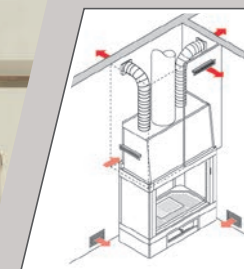

Kit UNO/bis, DUE/bis,
TRE/bis

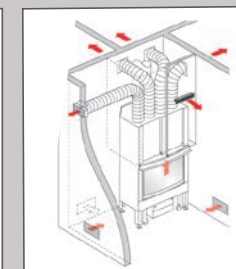

Kit QUATTRO/bis,
CINQUE/bis



OPTIONAL

Kit ventilazione completo di regolatore elettronico e telecomando | *Kit de ventilation complet avec régulateur électronique et télécommande* | Kit ventilación compuesto de regulador electrónico y telecomando | *Ventilator-Kit mit elektronischem Regler und Fernbedienung* | Complete fan kit including remote and electronic controller

Ideali per installazione a filo pavimento

Portellone scorrevole a scomparsa

Focolare in refrattario bianco o nero

A convezione naturale N

Uscite aria calda canalizzabile

-n°2 (Windo 70)

-n°4 (Windo 90, Windo 100, Windo 120)

Sistema di pulizia vetro

Post-combustione

Optional

- Cornice contorno bocca
- Dima per controcappa
- Kit ventilazione (installazione laterale)
- Kit UNO/bis, DUE/bis, TRE/bis
- Kit QUATTRO/bis, CINQUE/bis
- Kit AIR DIFFUSER adiacente
- Bocchette Split, Bent, Origami, Sharp

Idéal pour une installation à même le sol

Porte escamotable

Foyer en réfractaire blanc ou noir

Convection naturelle N

Sorties d'air chaud canalisables

-n°2 (Windo 70)

-n°4 (Windo 90, Windo 100, Windo 120)

Système de nettoyage vitre

Post-combustion

Optional

- *Cadre*
- *Gabarit pour contre-hotte*
- *Kit Ventilation (installation laterale)*
- *Kit uno/bis, DUE/bis, TRE/bis*
- *Kit QUATTRO/bis, CINQUE/bis*
- *kit air diffuser adjacent*
- *Bouches Split, Bent, Origami, Sharp*

Ideales para instalación a ras del suelo.

Puerta guillotina

Hogar refractario blanco o negro

Convección natural N

Salida aire caliente canalizable

-n°2 (Windo 70)

-n°4 (Windo 90, Windo 100, Windo 120)

Sistema de limpieza cristal

Postcombustión

Opcional:

- Cornisa contorno boca
- Soporte campana
- Kit de ventilación (instalación lateral)
- Kit UNO/bis, DUE/bis, TRE/bis
- Kit QUATTRO/bis, CINQUE/bis
- KIT AIR DIFFUSER "adyacente"
- Bocas de canalización Split, Bent, Origami y Sharp

Ideal für die bodenebene Installation

Schiebetür

Feuerraum aus weisser oder schwarzer Schamottsteine

Natürliche Belüftung N

Ausgänge zur Verteilung der Warmluft

-n°2 (Windo 70)

-n°4 (Windo 90, Windo 100, Windo 120)

Glasspülung

Nachbrennsystem

Optional

- *Rahmen*
- *Schablone für Gegenhaube*
- *Ventilator-Kit (seitliche Installation)*
- *Kit UNO/bis, DUE/bis, TRE/bis*
- *Kit QUATTRO/bis, CINQUE/bis*
- *kit AIR DIFFUSER "Nahegelen"*
- *Luftauslässen der Warmluftverteilung*
- *Split, Bent, Origami, Sharp*

Suitable for a flush-to-floor installation

Sliding door

Combustion chamber black or white refractory

Natural convection N

Outputs for ducting hot air

-n°2 (Windo 70)

-n°4 (Windo 90, Windo 100, Windo 120)

Glass cleaning system

Post-combustion system

Optional

- Frame
- Hood mounting template
- Fan kit (side fitting)
- Kit UNO/bis, DUE/bis, TRE/bis
- Kit QUATTRO/bis, CINQUE/bis
- kit AIR DIFFUSER "Adjacent"
- Ducting vents Split, Bent, Origami, Sharp

Classe ambientale
DM 186



Windo 70

Windo 70



Windo 90



Windo 100 | Windo 120



* Prodotti in fase di certifica | *En cours de certification* | En fase de certificación | *In der Zertifizierungsphase* | Certification in progress

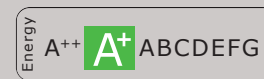

Windo 70

Blokk 70

14,3 kW 375 m³ 88x53x169h cm

Blokk 90

*17 kW 469 m³ 108x53x189h cm

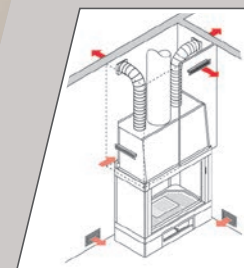
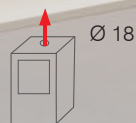

Kit UNO/bis, DUE/bis,
TRE/bis

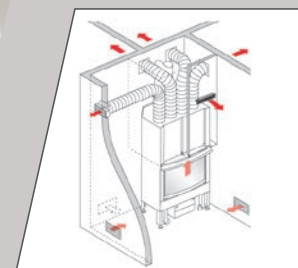

Kit QUATTRO/bis,
CINQUE/bis

Portellone scorrevole a scomparsa	<i>Porte escamotable</i>	Puerta guillotina	<i>Schiebetür</i>	Sliding door
Focolare in refrattario bianco o nero	<i>Foyer en réfractaire blanc ou noir</i>	Hogar refractario blanco o negro	<i>Feuerraum aus weisser oder schwarzer Schamottsteine</i>	Combustion chamber black or white refractory
Versione a convezione naturale N	<i>Convection naturelle N</i>	Convección natural N	<i>Natürliche Belüftung N</i>	Natural convection N
Versione ventilata V con ventilatore integrato	<i>Ventilation forcée V avec ventilateur intégré</i>	Ventilación forzada V con ventilador integrado	<i>Gebälsebelüftung V Integrierter Ventilator</i>	Forced ventilation V built-in fan
Aria calda canalizzabile uscite superiori (n°4)	<i>Sorties d'air chaud canalisables (n°4)</i>	Aire caliente canalizable superior (n°4)	<i>Ausgänge zur Verteilung der Warmluft (n°4)</i>	Outputs for ducting hot air (n°4)
Post-combustione	<i>Post-combustion</i>	Postcombustión	<i>Nachbrennsystem</i>	Post-combustion system
Sistema di pulizia vetro	<i>Système de nettoyage vitre</i>	Sistema de limpieza cristal	<i>Glasspülung</i>	Glass cleaning system
Optional	<i>Optional</i>	Opcional	<i>Optional</i>	Optional
• Cornice contorno bocca	• <i>Cadre</i>	• Cornisa contorno boca	• <i>Rahmen</i>	• Frame
• Dima per controcapa	• <i>Gabarit pour contre-hotte</i>	• Soporte campana	• <i>Schablone für Gegenhaube</i>	• Hood mounting template
• Kit UNO/bis, DUE/bis, TRE/bis, Kit QUATTRO/bis, CINQUE/bis	• <i>Kit UNO/bis, DUE/bis, TRE/bis, Kit QUATTRO/bis, CINQUE/bis</i>	• Kit UNO/bis, DUE/bis, TRE/bis, Kit QUATTRO/bis, CINQUE/bis	• <i>Kit UNO/bis, DUE/bis, TRE/bis, Kit QUATTRO/bis, CINQUE/bis</i>	• Kit UNO/bis, DUE/bis, TRE/bis, Kit QUATTRO/bis, CINQUE/bis



Blokk 70



Kit ventilazione completo di regolatore elettronico e telecomando

Kit de ventilation complet avec régulateur électronique et télécommande

Kit ventilación compuesto de regulador electrónico y telecomando

Ventilator-Kit mit elektronischem Regler und Fernbedienung

Complete fan kit including remote and electronic controller

* Prodotti in fase di certifica | *En cours de certification* | En fase de certificación | *In der Zertifizierungsphase* | Certification in progress

Blokk 70 | Blokk 90



Blokk 70



I modelli T sono dotati di:

- **scambiatore di calore** da installare sopra il focolare
- **ventilazione.**

Garantiscono così la conformità ai requisiti previsti per accedere al Conto Termico.

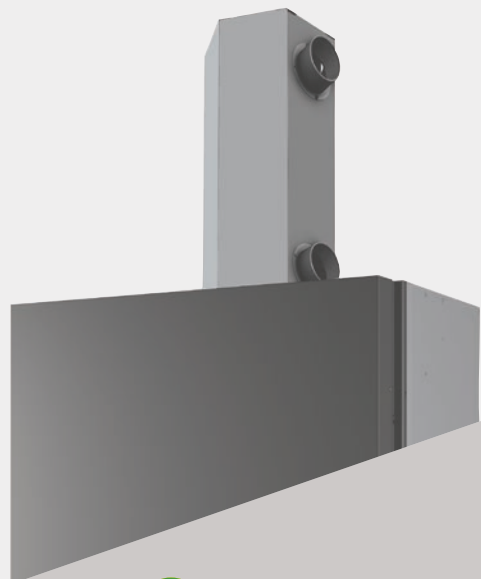

FOCOLARI A LEGNA | CHEMINÉES À BOIS | CHIMENEAS DE LEÑA | HOLZKAMINEINSÄTZE | WOOD FIREPLACES

Windo 70 T | Windo 90 T

15,5 kW 405 m³ 93x53x208h cm * 18 kW 470 m³ 113x53x223h cm

Con scambiatore di calore e Kit Air Diffuser *Con intercambiador de calor y Kit Air Diffuser*

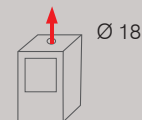

Ideali per installazione a filo pavimento

Ideales para instalación a ras del suelo

Portellone scorrevole a scomparsa

Puerta guillotina

Focolare in refrattario bianco o nero

Hogar refractario blanco o negro

Aria calda canalizzabile uscite superiori (n°2 Windo 70 T) (n°4 Windo 90 T)

Aire caliente canalizable superior (n°2 Windo 70 T) (n°4 Windo 90 T)

Sistema di pulizia vetro

Sistema de limpieza cristal

Optional

- Cornice contorno bocca
- Dima per controcapa
- Bocchette Split, Bent, Origami, Sharp

Opcional

- *Cornisa contorno boca*
- *Soporte campana*
- *Bocas de canalización Split, Bent, Origami y Sharp*

PER MERCATO ITALIANO

PARA MERCADO ESPAÑOL



Windo 70 T
Blokk 70 T



Windo 90 T
Blokk 90 T



Windo 70 T
Blokk 70 T

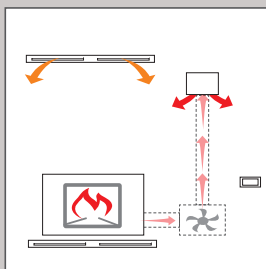

KIT AIR DIFFUSER

* Prodotti in fase di certifica | *En fase de certificación*

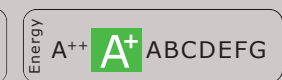

Windo 70 T

Blokk 70 T | Blokk 90 T

15,5 kW 405 m³ 88x53x242h cm *18 kW 443 m³ 108x53x263h cm

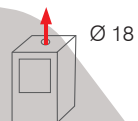

Con scambiatore di calore e ventilatore integrato | Con intercambiador de calor y ventilador integrado

Portellone scorrevole a scomparsa | Puerta guillotina

Focolare in refrattario bianco o nero | Hogar refractario blanco o negro

Aria calda canalizzabile uscite superiori (n°4) | Aire caliente canalizable superior (n°4)

Post-combustione | Postcombustión

Sistema di pulizia vetro | Sistema de limpieza cristal

Optional

- Cornice contorno bocca
- Dima per controcappa
- Kit UNO/bis, DUE/bis, TRE/bis, Kit QUATTRO/bis, CINQUE/bis

Opcional

- Cornisa contorno boca
- Soporte campana
- Kit UNO/bis, DUE/bis, TRE/bis, Kit QUATTRO/bis, CINQUE/bis

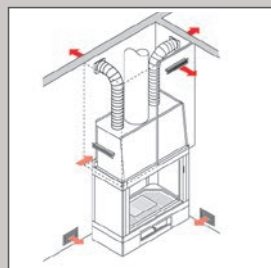

Kit UNO/bis,
DUE/bis,
TRE/bis

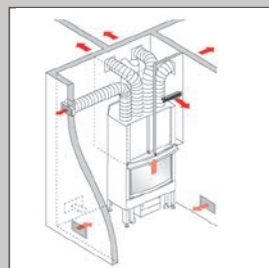

Kit QUATTRO/bis,
CINQUE/bis



Regolatore elettronico e telecomando
Regulador electrónico y telecomando



* Prodotti in fase di certifica | En fase de certificación



Blokk 70 T

Milla H 15

15,3 kW 13 kW (H₂O) 400 m³ 52x56x110h cm

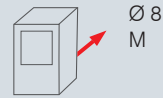

Fianchi in acciaio, top in ceramica bianco panna, bordeaux, nero lucido, pergamena

Flancs en acier et top en céramique blanc crème, bordeaux, noir brillant, parchemin

Laterales acero y top de cerámica blanco crema, burdeos, negro brillo, pergamino

Seitenteile aus Stahl, Top und Einsätze aus Keramik Weiß, bordeaux, glänzend schwarz, Pergament

Steel sides, top and inserts in ceramic cream white, bordeaux, shiny black, parchment

Focolare in acciaio

Foyer en acier

Hogar de acero

Feuerraum aus Stahl

Steel combustion chamber

Display sul top

Panneau synoptique

Panel sinóptico

Bedienfeld

Display

Kit idraulico incorporato con vaso espansione chiuso, circolatore e valvola di sovrappressione

Kit incorporé avec vase d'expansion fermé, circulateur et groupe de sécurité

Kit hidráulico incorporado con tanque de expansión cerrado, circulador y válvula de alivio de presión

Hydraulikbausatz mit geschlossenem Ausdehnungsgefäß, Umwälzpumpe und Überdruckventil

Hydraulic kit with closed expansion tank, circulator pump and pressure relief valve.

Programmazione giornaliera/settimanale

Programmation journalière/hebdomadaire

Programación diaria/semanal

Tages-/Wochen-Zeitprogrammierung

Daily/weekly program

Ventilazione aria calda (disattivabile)

Ventilation air chaud (désactivable)

Aire caliente frontal (desactivable)

Ausschaltbares Warmluftgebläse

Deactivatable hot air ventilation

Optional:

- Kit radiocomando con ricevitore
- Kit Wi-Fi H
- Combinatore telefonico H
- Kit idraulici

Optional:

- *Radiocomando*
- *Kit WI-FI H*
- *Combinateur téléphonique H*
- *Kits hydraulique*

Opcional:

- Radiomando
- Kit WI-FI H
- Telefoonschakelaar Apparat H
- Kit hidráulico

Optional:

- Funkfernbedienung
- *Kit WI-FI H*
- *Telefonschalter Ausrüstung H*
- *Hydraulik-kits*

Optional:

- Radio remote control
- Kit WI-FI H
- Telephone switcher H
- Hydraulic kits



Classe ambientale DM 186 ★★★★★



Ceramica - Acciaio | *Céramique - Acier* |
Cerámica - Acero | *Keramik - Stahl* | Ceramic - Steel

Bordeaux
Bordeaux
Bordeaux
Bordeaux
Bordeaux

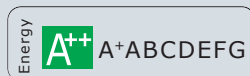



Pergamena
Parchemin
Pergamino
Pergament
Parchment



Ceramica bianco opaco
C ramique blanc opaque
Cer mica blanca opaca
Matt-Wei e Keramik
Matt white ceramic



Myrna H 15

15,3 kW 13 kW (H₂O) 400 m³ 54,5x59,5x112h cm

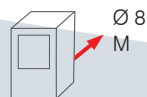

Acciaio con inserto frontale e top in ceramica bianco opaco, cipria o grigio chiaro opaco.

Acier avec insert frontal et top en céramique blanc opaque, rose poudré ou gris clair

Acero con detalle frontal y top en cerámica blanca opaca, cipria o gris claro

Stahl mit Fronteinsatz und Top aus matter weißer, puder oder hellgrauer Keramik

Steel with front insert and matt white, powder or light grey colors ceramic top

Focolare in acciaio

Foyer en acier

Hogar de acero

Feuerraum aus Stahl

Steel combustion chamber

Display sul top a scomparsa

Panneau synoptique

Panel sinóptico

Bedienfeld

Display

Kit idraulico incorporato con vaso espansione chiuso, circolatore e valvola di sovrappressione

Kit incorporé avec vase d'expansion fermé, circulateur et groupe de sécurité

Kit hidráulico incorporado con tanque de expansión cerrado, circulador y válvula de alivio de presión

Hydraulikbausatz mit geschlossenem Ausdehnungsgefäß, Umwälzpumpe und Überdruckventil

Hydraulic kit with closed expansion tank, circulator pump and pressure relief valve.

Programmazione giornaliera/settimanale

Programmation journalière/hebdomadaire

Programación diaria/semanal

Tages-/Wochen-Zeitprogrammierung

Daily/weekly program

Ventilazione aria calda (disattivabile)

Ventilation air chaud (désactivable)

Aire caliente frontal (desactivable)

Ausschaltbares Warmluftgebläse

Deactivatable hot air ventilation

Optional:

- Kit radiocomando con ricevitore
- Kit Wi-Fi H
- Combinatore telefonico H
- Kit idraulici

Optional:

- Radiocommande
- Kit WI-FI H
- Combinateur téléphonique H
- Kits hydraulique

Opcional:

- Radiomando
- Kit WI-FI H
- Combinador telefónico H
- Kit hidráulico

Optional:

- Funkfernbedienung
- Kit WI-FI H
- Telefonschalter Ausrüstung H
- Hydraulik-kits

Optional:

- Radio remote control
- Kit WI-FI H
- Telephone switcher H
- Hydraulic kits



Classe ambientale DM 186 ★★★★★



Ceramica | Céramique | Cerámica
Keramik | Ceramic

Ceramica grigio chiaro opaco
Céramique gris clair opaque
Cerámica gris claro opaca,
Hellgraue matte Keramik
Matt light grey ceramic

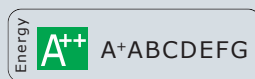

Widro 55 | Widro 65 | Widro 85
Widro 55 CS | Widro 65 CS | Widro 85 CS

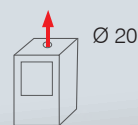

* 24 kW 16,5 kW (H₂O) 650 m³
75x68x161,5 h cm

* 25,7 kW 18 kW (H₂O) 670 m³
85x68x161,5 h cm

* 29 kW 20 kW (H₂O) 755 m³
105x68x161,5h cm



Termocamino per l'alimentazione dell'impianto di riscaldamento

Disponibile per installazione a vaso aperto e vaso chiuso (Widro 55 CS, Widro 65 CS, Widro 85 CS), con 1 serpentina

Portellone che si apre a saliscendi e a ribalta per la pulizia del vetro

Focolare in refrattario bianco

Piedini con ruote per agevolare l'installazione

Post-combustione

Braciere e attacco per girarrosto

Optional

- Cornice contorno bocca
- Dima per controcappa
- Gruppo spiedo con leccarda inox
- Kit idraulici

Thermo-cheminée pour l'alimentation du système de chauffage

Disponible pour installation à vase ouvert et à vase fermé CS (Widro 55 CS, Widro 65 CS, Widro 85 CS), avec 1 serpentin

Porte qui s'ouvre de haut en bas pour le nettoyage de la vitre

Foyer en réfractaire blanc

Pieds avec roues pour faciliter le mouvement lors de l'installation.

Post-combustion

Avec brasero, fixation pour tournebroche.

En option

- *Cadre*
- *Gabarit pour contre-hotte*
- *Grupo broche avec tige inox*
- *Kits hydrauliques*

Termochimenea para la alimentación del sistema de calefacción.

Disponible para instalación vaso abierto y vaso cerrado (Widro 55 CS, Widro 65 CS, Widro 85 CS), con 1 serpentin

Puerta que se abre a guillotina y también abatible para la limpieza del cristal.

Hogar refractario blanco

Pies con ruedas para facilitar el movimiento durante la instalación

Postcombustión

Brasero y soporte para rustidor

Opcional

- Cornisa contorno boca
- Soporte campana
- Conjunto asador con varilla inox
- Kit hidráulico

Heizkamin zur Speisung der Heizungsanlage

Verfügbar für die Installation mit offenem und geschlossenem Ausdehnungsgefäß (Widro 55 CS, Widro 65 CS, Widro 85 CS), mit 1 Kühlschlange

Hochschiebbare Tür die sich zur Glasreinigung auch nach vorne öffnet

Weisse Schamottsteine

Füße mit Rädern zur Erleichterung der Bewegung während der Installation

Nachbrennsystem

Kohlebecken und Drehspieß

Optional

- *Rahmen*
- *Schablone für Gegenhaube*
- *Spießgruppe mit Edelstahl-Auffangschale*
- *Hydraulik-kits*

Thermo-fireplace powering a direct heating system

Available with open and closed vessel tank (Widro 55 CS, Widro 65 CS, Widro 85 CS) with coil

Tilt and ups & downs door opening for the glass cleaning

Combustion chamber white refractory

Post-combustion system

Pivoting wheels easing handling while fitting

Brazier with rotisserie hooks

Optional

- Frame
- Hood mounting template
- Grill kit with dripping pan
- Hydraulic kits



* Prodotti in fase di certifica | *En cours de certification* | En fase de certificación | *In der Zertifizierungsphase* | Certification in progress



Widro 85



Gora 22

21,5 kW 20,1 kW (H₂O) 525 m³

Gora 26

25,8 kW 24 kW (H₂O) 625 m³

Gora 29

29,2 kW 27 kW (H₂O) 705 m³ 55x78x131h cm



Focolare in acciaio e ghisa

Display frontale

Doppia porta isolata

Vaso d'espansione chiuso

Programmazione giornaliera/settimanale

Classe 5 secondo le norme EN 303-5

Optional
 • Kit WI-FI H
 • kit idraulici preassemblati (obbligatorio per un corretto funzionamento)

Foyer en acier et fonte

Panneau synoptique avec écran frontal

Double porte isolée

Vase d'expansion fermé incorporé

Programmation journalière/hebdomadaire

Classe 5 selon norme EN 303-5

Optional
 • *Kit WI-FI H*
 • *Kits hydrauliques (obligatoire pour un bon fonctionnement)*

Hogar de acero y fundición

Panel sinóptico en el frontal

Doble puerta aislada

Vaso expansión cerrado

Programación diaria/semanal

Clase 5 según las normas EN 303-5

Opcional
 • Kit WI-FI H
 • Kit hidráulico (indispensable para un correcto funcionamiento)

Feuerraum aus Stahl, und Gusseisen

Bedienfeld mit vorderem Display

Doppelt isolierte Tür

Geschlossenes Ausdehnungsgefäß inbegriffen

Tages-/Wochen-Zeitprogrammierung

Klass 5 nach den Normen EN 303-5

Optional
 • *Kit WI-FI H*
 • *Hydraulik-kits: (verpflichtend für den korrekten Betrieb)*

Steel and cast iron combustion chamber

Display

Insulated double door

Included closed expansion tank

Daily/weekly program

Class 5 according to the standards: EN 303-5

Optional
 • Kit WI-FI H
 • Hydraulic kits (required for proper functioning)



Gora 22



Gora 26
Gora 29

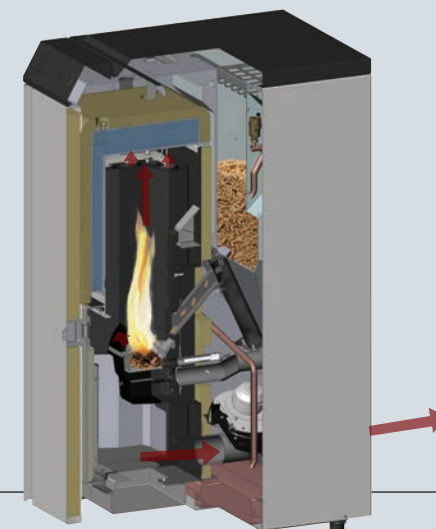





Gora Slim

21,5 kW 20,1 kW (H₂O) 525 m³ 107x44x129h cm

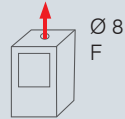

Focolare in acciaio

Foyer en acier

Hogar de acero

Feuerraum aus Stahl

Steel combustion chamber

Display frontale

Panneau synoptique avec écran frontal

Panel sinóptico en el frontal

Bedienfeld mit vorderem Display

Display

Doppia porta isolata

Double porte isolée

Doble puerta aislada

Doppelt isolierte Tür

Insulated double door

Vaso d'espansione chiuso

Vase d'expansion fermé incorporé

Vaso expansión cerrado

*Geschlossenes Ausdehnungsgefäß
inbegriffen*

Included closed expansion tank

Programmazione giornaliera/settimanale

*Programmation
journalière/hebdomadaire*

Programación diaria/semanal

Tages-/Wochen-Zeitprogrammierung

Daily/weekly program

Doppia pulizia del crogiolo e dei turbolatori (EKleaner)

*Double nettoyage du creuset et des
turbulateurs (EKleaner)*

Doble limpieza, del crisol y de los
turboladores (EKleaner)

*Doppelreinigung der Brennschale
und der Turbolatoren (EKleaner)*

Double cleaning of the burning pot and
the turbulators (EKleaner)

**Classe 5
secondo le norme EN 303-5**

**Classe 5
selon norme EN 303-5**

**Clase 5
según las normas EN 303-5**

**Klass 5
nach den Normen EN 303-5**

**Class 5
according to the standards: EN 303-5**

Optional

- Kit WI-FI H
- kit idraulici preassemblati (obbligatorio per un corretto funzionamento)

Optional

- *Kit WI-FI H*
- *Kits hydrauliques (obligatoire pour un bon fonctionnement)*

Opcional

- Kit WI-FI H
- Kit hidráulico (indispensable para un correcto funcionamiento)

Optional

- *Kit WI-FI H*
- *Hydraulik-kits: (verpflichtend für den korrekten Betrieb)*

Optional

- Kit WI-FI H
- Hydraulic kits (required for proper functioning)

CONTO
TERMICO

Classe
ambientale
DM 186

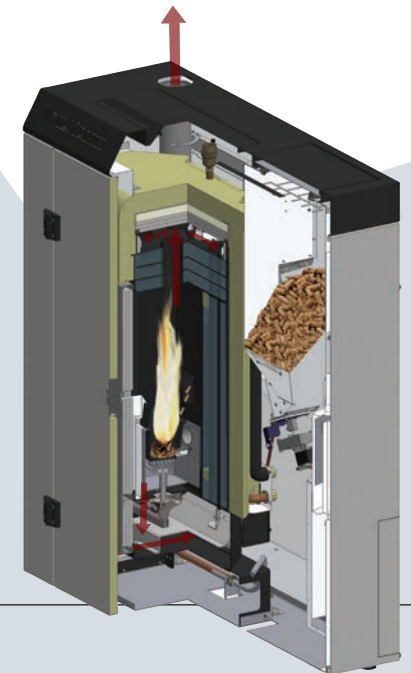

Dania Air Tight, Dania Air Tight Plus,
Dania Air Tight C, Dania Air Tight C Plus

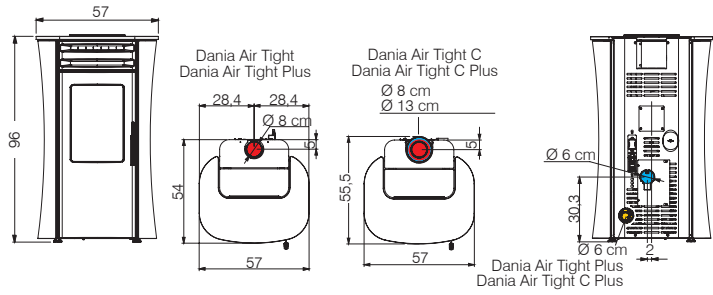

Celia Air Tight, Celia Air Tight Plus,
Celia Air Tight C, Celia Air Tight C Plus

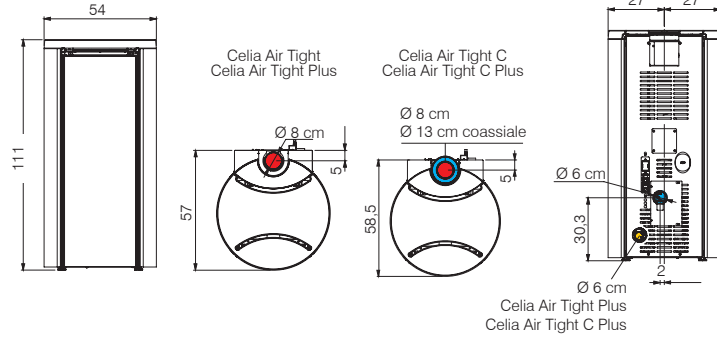

Micol, Micol Plus

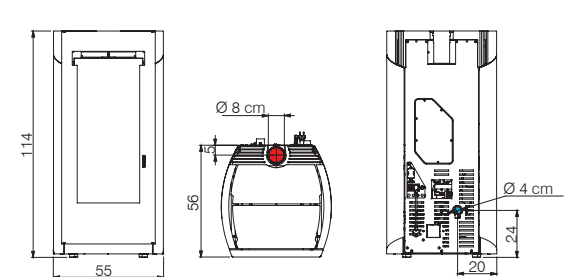

Mirna, Mirna Plus

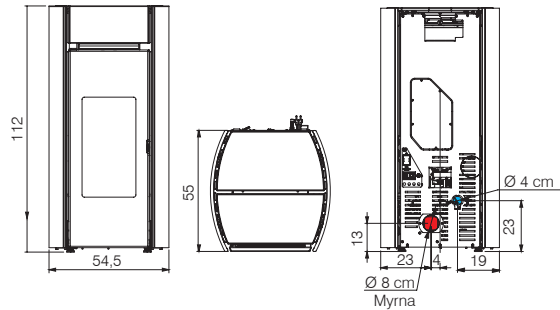

Mirna Q, Mirna Q Plus

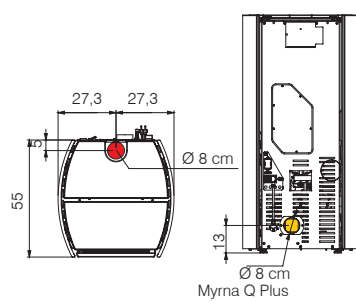

Yana, Yana Plus

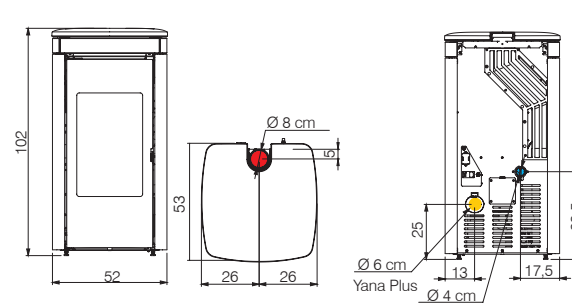

Lena, Lena Plus

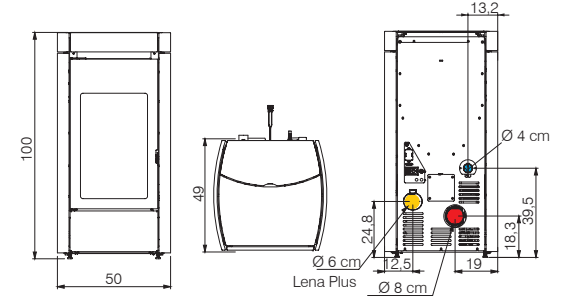

Windo 70 / Windo 90

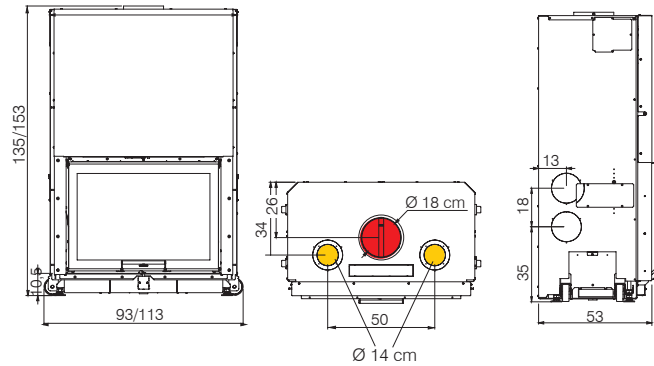

Windo 100 / Windo 120

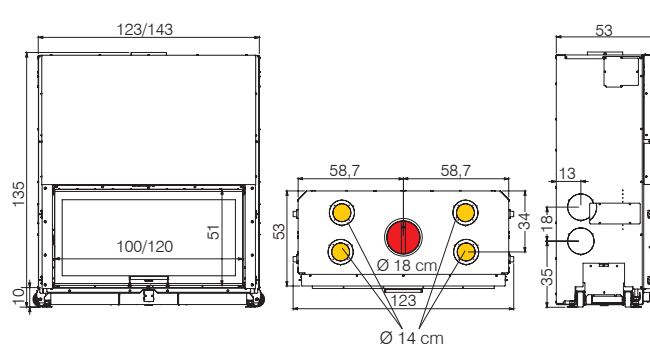

Blokk 70 / Blokk 90

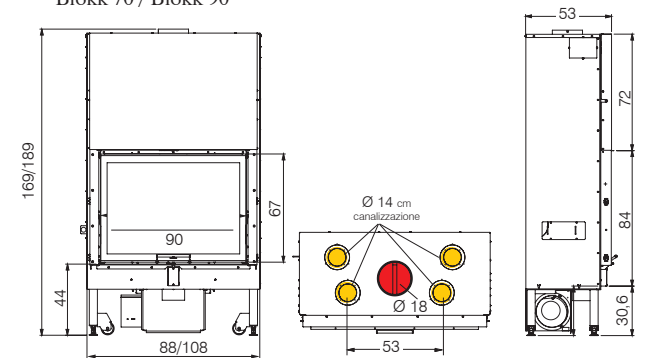

Windo 70 T / Windo 90 T

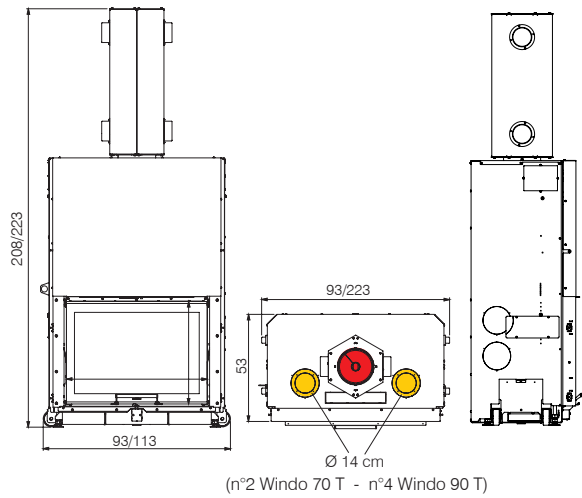

Blokk 70 T / Blokk 90 T

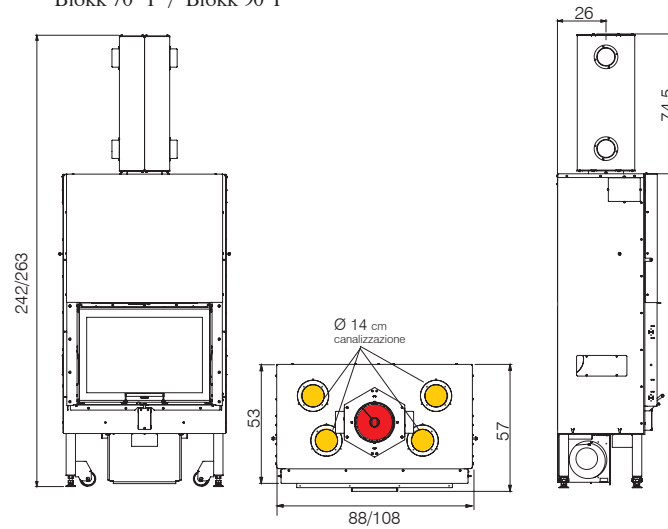

Myrna H 15

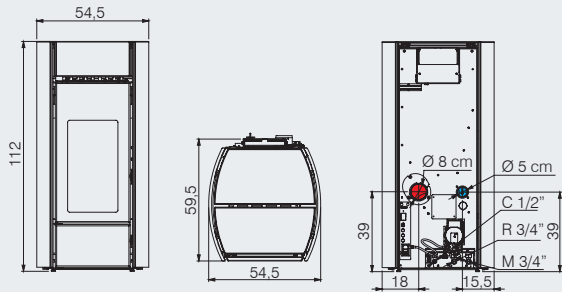

Milla H 15

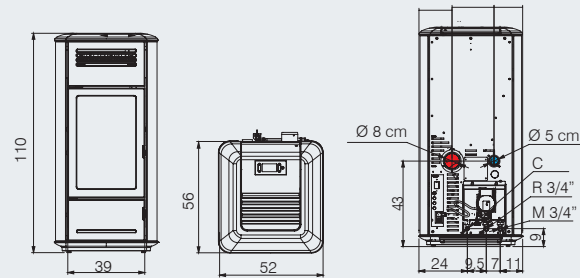

Widro 85

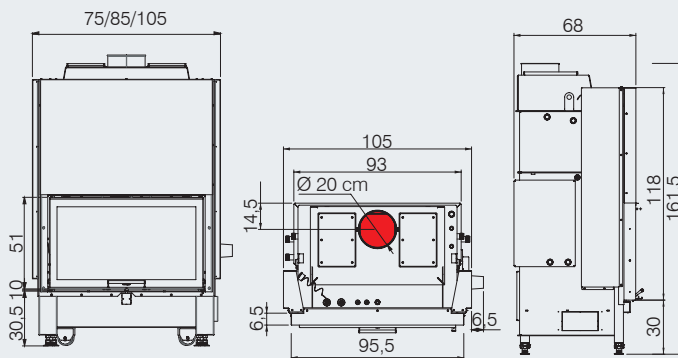



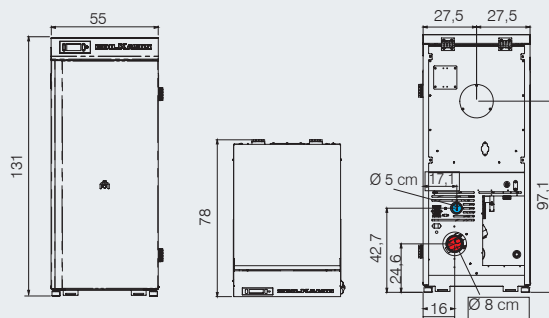



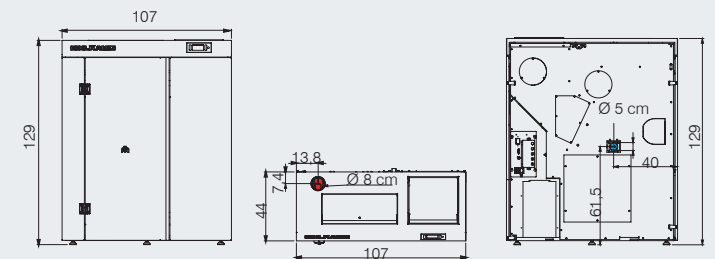

























Gora 22, Gora 26, Gora 29



Gora Slim



														
	*Dania Air Tight Plus *Dania Air Tight Plus	*Dania Air Tight C Plus *Dania Air Tight C Plus	*Celia Air Tight Plus *Celia Air Tight Plus	*Celia Air Tight C Plus *Celia Air Tight C Plus	Yana Plus Yana Plus	Lena Plus Lena Plus	*Micol Plus *Micol Plus	*Myrna Plus *Myrna Plus	*Myrna Q Plus *Myrna Q Plus	Blokk 70 *Blokk 90	Blokk 70 T *Blokk 90 T	Windo 70 *Windo 90	Windo 70 T *Windo 90 T	*Windo 100 *Windo 120
kW 	*6 *8	*6 *8	*7 *9	*7 *9	6,9 9,2	7,9 9,2	*10 *12	*10 *12	*10 *12	14,3 *17	15,5 *18	14,3 *17	15,5 *18	*18 *19
Kg 	15 15	15 15	20 20	20 20	20 20	24 24	26 26	26 26	26 26	-	-	-	-	-
kg/h 	0,6-1,4 0,6-1,9	0,6-1,4 0,6-1,9	0,6-1,6 0,6-2,1	0,6-1,6 0,6-2,1	0,7-1,6 0,9-2,2	0,7-1,9 0,9-2,2	1-2,3 1-2,8	1-2,3 1-2,8	1-2,3 1-2,8	4 5	4 4,3	4 4,7	4 4,6	5 5,3
h 	11-25 8-25	11-25 8-25	13-33 10-33	13-33 10-33	13-29 9-22	13-34 11-27	11-26 9-26	11-26 9-26	11-26 9-26	-	-	-	-	-
m³ 	155 210	155 210	180 235	180 235	180 240	205 240	260 315	260 315	260 315	375 469	405 443	375 445	405 470	470 495
% 	90 90	90 90	90 90	90 90	88 88,5	87,1 88,5	90 90	90 90	90 90	81,4 78	87,2 85	81,4 78	87,2 85	78 78
	↑ Ø 8	⊙ ↑ Ø 8/13	↑ Ø 8	⊙ ↑ Ø 8/13	↑ Ø 8	↗ Ø 8	↑ Ø 8	↗ Ø 8	↑ Ø 8	↑ Ø 18	↑ Ø 18	↑ Ø 18	↑ Ø 18	↑ Ø 18
	- n° 1x Ø 6 (plus)	- n° 1x Ø 6 (plus)	- n° 1x Ø 6 (plus)	- n° 1x Ø 6 (plus)	- n° 1x Ø 6 (plus)	- n° 1x Ø 6 (plus)	- n° 1x Ø 8 (plus)	- n° 1x Ø 8 (plus)	- n° 1x Ø 8 (plus)	n° 4x Ø 14	n° 4x Ø 14	n° 2x Ø 14 n° 4x Ø 14	n° 2x Ø 14 n° 4x Ø 14	n° 4x Ø 14
N 	-	-	-	-	-	-	-	-	-	N - V	V	N	V	N
Kg 	133 137	133 137	148 152	148 152	132 135	110 113	160 163	160 163	160 163	310 - 330 340 - 360	380 410	220 250	250 280	380 430
SL 	•	•	•	•	•	•	•	•	•	-	-	-	-	-
	•	•	•	•	•	•	•	•	•	-	-	-	-	-
	•	•	•	•	•	•	•	•	•	-	-	-	-	-
	•	•	•	•	•	•	•	•	•	-	-	-	-	-
	•	•	•	•	•	•	•	•	•	-	-	-	-	-
30± RELAX 	•	•	•	•	•	•	•	•	•	-	-	-	-	-
AT PH 	•	•	•	•	-	-	-	-	-	-	-	-	-	-
	•	•	•	•	•	•	•	•	•	-	-	-	-	-
		-	-	-	-	-	-	-	-	•	•	•	•	•

*Prodotti in fase di certifica_En cours de certification_Datos en curso de certiticación_In Zertifizierungsphase_Certification in progress

*Dati di progetto_Données de projet_Datos de proyecto_Projektdataen_Project data



Milla H 15

Myrna H 15

Gora Slim

Gora 22
Gora 26
Gora 29*Widro 55
*Widro 65
*Widro 85

	Milla H 15	Myrna H 15	Gora Slim	Gora 22 Gora 26 Gora 29	*Widro 55 *Widro 65 *Widro 85
	15,3	15,3	21,5	21,5 25,8 29,2	*24 *25,7 *29
	13	13	20,1	20,1 24 27	16,5 18 20
	24	26	40	60	-
	0,7-3,5	0,7-3,5	1,3-4,5	1,4-4,5 1,4-5,4 1,4-6,1	6,1 6,6 7,4
	7-34	7-37	9-31	13-43 11-43 10-43	-
	400	400	525	525 625 705	650 670 755
	92,1	92,1	93,4	93,5 92,9 92,5	85 85 85
	Ø 8 ↗	Ø 8 ↗	Ø 8 ↑	Ø 8 →	20 ↑
	13	13	20	40	80 90 110
	189	160	233	302 335 328	484 494 516
	•	•	•	•	-
	•	•	•	•	-
	•	•	•	•	-
	optional	optional	optional	optional	-
	•	•	•	•	-
	•	•	•	•	-
	-	-	-	-	•

LEGENDA SIMBOLI | LÉGENDE SYMBOLES | LEYENDA SÍMBOLOS | SYMBOL ANGABE | SYMBOLS KEY



kW min max



*Volume riscaldabile | *Volume de chauffe* |
Volumen calentable | *Beheizbarer Rauminhalt* |
Heatable volume



Rendimento | *Rendement* | Rendimiento |
Wirkungsgrad | Efficiency



Contenuto d'acqua | *Contenu d'eau* |
Contenido de agua | *Wasserinhalt* | Water capacity



Uscita fumi | *Sortie fumées* | Salida humos
Rauchabzug | Smoke outlet

↑ Superiore | *Vers le haut* | Superior | *Oben* | Top

→ Laterale | *Latérale* | Lateral | *Seitlich* | Side

↖ Posteriore | *À l'arrière* | Trasera | *Hinten* | Rear

M: Maschio | *mâle* | macho | *feder* | male

F: Femmina | *femelle* | hembra | *nut* | female



Canalizzazione aria calda | *Sortie air chaud* |
Salida aire caliente | *Warmluftauslass* | *Hot air outlet*
n° x Ø cm



ON-OFF: Ventilazione aria calda disattivabile |
Ventilation air chaud désactivable | Ventilación con aire caliente
desactivable | *Ausschaltbares Warmluftgebläse* | Deactivatable
hot air ventilation



Funzione EASY TIMER consente di ritardare l'accensione e
lo spegnimento della stufa |
La fonction EASYTIMER permet de programmer l'allumage et
l'extinction du poêle |
Función EASYTIMER permite programar el encendido y
el apagado de la estufa |
Die EASYTIME -Funktion ermöglicht die automatische Zündung/
Ausschaltung des Ofens/
EASY TIMER feature for stove ON/OFF programming



Adatta per le moderne case passive | *Adapté pour les maisons*
passives modernes | Ideal para las casas pasivas modernas |
Raumluftunabhängig | Suitable for modern passive houses



Confortclima



Programmatore orario settimanale | *Programmeur horaire*
hebdomadaire | Programador horario semanal |
Wöchentliche Stunden-Programmierung | Weekly time pro-
grammer



Autoclean: pulizia automatica del crogiolo |
Nettoyage automatique du creuset | Limpieza automática del
cristal | *Automatische Reinigung des Brenntiegels* |
Automatic combustion chamber cleaning



kW Acqua
Eau | al agua | *Wasser* | Water



**Consumo pellet | *Consommation* |
Consumo | *Verbrauch* | Consumption
min/max



Peso | *Poids avec emballage* |
Peso con embalaje | *Gewicht* | Weight with packaging



Riserva pellet | *Réservoir* | Depósito pellet |
Pelletbehälter | Pellet hopper



Autonomia | *Autonomie* | Autonomía |
Autonomie | Autonomy min-max



Post combustione |
Post-combustion | Postcombustión |
Nachbrennsystem | Post-combustion system



Sistema Leonardo: sistema in grado di gestire automa-
ticamente la combustione del pellet |
*Système capable de gérer automatiquement la combus-
tion du pellet* | Para la gestión de la combustión
automática del pellet | *Für die automatische Steuerung*
der Pelletverbrennung |
For automatic pellet management



Funzione RELAX: ventilazione aria calda disattivabile |
Fonction RELAX: ventilation air chaud désactivable |
Función RELAX: ventilación con aire caliente desactivable |
RELAX Funktion: Ausschaltbares Warmluftgebläse |
RELAX function: deactivatable hot air ventilation



KIT Wi-Fi | *Wi-Fi kit* | kit *Wi-Fi* | *kit Wi-Fi* | Wi-Fi kit



Fire control:
regolatore automatico della combustione | *Régulateur*
automatique de la combustion | Regulador automático de la
combustión | *Automatischer Verbrennungsregler* |
Automatic combustion control



Stufe stagne | *Poêles «étanches»* |
Estufas de pellet estanca | *Raumluftunabhängige Öfen* |
"Airtight" stoves



Convezione naturale | *Convection Naturelle* | Convección
natural | *Natürliche belüftung* | Natural convection



Ventilazione forzata | *Ventilation Forcée* | Ventilación
forzada | *Gebäsebelüftung* | Forced ventilation



Display | *Panneau synoptique* | Panel sinóptico
Bedienfeld | Display

* Il volume riscaldabile è calcolato sulla base di una necessità di 33 kcal/m³h | *Le volume de chauffe est calculé sur la base d'une nécessité de 33 kcal/m³ h.* |
El volumen calentable se calcula en base a una necesidad de 33 kcal/m³h | *Das heizbare Volumen wird auf Grundlage eines Bedarfs von 33 kcal/m³ h berechnet.* |
The heatable volume is calculated based on a requirement of 33 kcal/m³h

**Per il calcolo del consumo del combustibile si è utilizzato un potere calorifico di 4,8 kW/kg | *Pour le calcul de la consommation de combustible, on a utilisé*
une puissance calorifique de 4,8 kW/kg | Para el cálculo del consumo de combustible se usa un poder calorífico de 4,6 kW/kg para la leña y 4,8kW/kg para el pellet.
| *Zur Berechnung des Brennstoffverbrauchs wird ein Heizwert von 4,8 kW/kg* | The calculation of fuel consumption assumes a calorific value of 4,8 kW/kg



MK Technika Grzewcza i Klimatyzacja

45-368 Opole, ul. Ozimska 53
tel. 77 453-14-14, 77 402-14-70, 77 402-14-71
fax 77 402-14-70, 77 402-14-71
e-mail: biuro@mk.net.pl
www.mk.net.pl

AL 945627-E 6.02.20

 **EDILKAMIN**
www.edilkamin.com

EDILKAMIN S.p.A.

_Si riserva la facoltà di modificare in qualunque momento, senza preavviso, le caratteristiche tecniche ed estetiche degli elementi illustrati e declina ogni responsabilità per eventuali errori di stampa presenti. Le immagini sono puramente indicative. Per una corretta installazione seguire quanto riportato sulle schede tecniche. _Se réserve la faculté de modifier à tout moment, sans préavis, les caractéristiques techniques et esthétiques des éléments illustrés et décline toute responsabilité pour d'éventuelles erreurs d'impression présentes dans le catalogue. _Se reserva la facultad de modificar en cualquier momento, sin previo aviso, las características técnicas y estéticas de los elementos ilustrados declina cualquier responsabilidad por posibles errores de impresión presentes en el catálogo. _Der Hersteller behält sich das Recht vor, ohne Vorankündigung die technischen und ästhetischen Merkmale der im vorliegenden Katalog abgebildeten Elemente jederzeit zu ändern. Er übernimmt keine Haftung für eventuelle Druckfehler. _Reserves the right to change the technical and aesthetic specifications of the components illustrated in this catalogue, at any time and without prior notice and declines all responsibility for any printing errors in this catalogue.